

THE PROPERTY OF THE DRAWING IS ESTABLISHED BY LAW. IT IS FORBIDDEN TO PRODUCE OR SHOW IT TO THIRD PART. WITHOUT A WRITTEN AGREEMENT.

Item	Name	Q.ty
1	CA.08.09.05	1
2	GSEG.100515	1

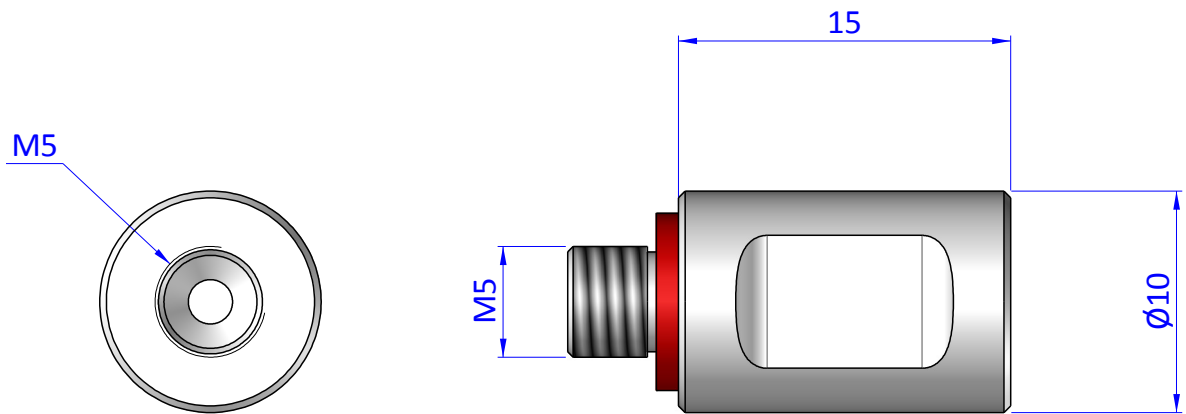
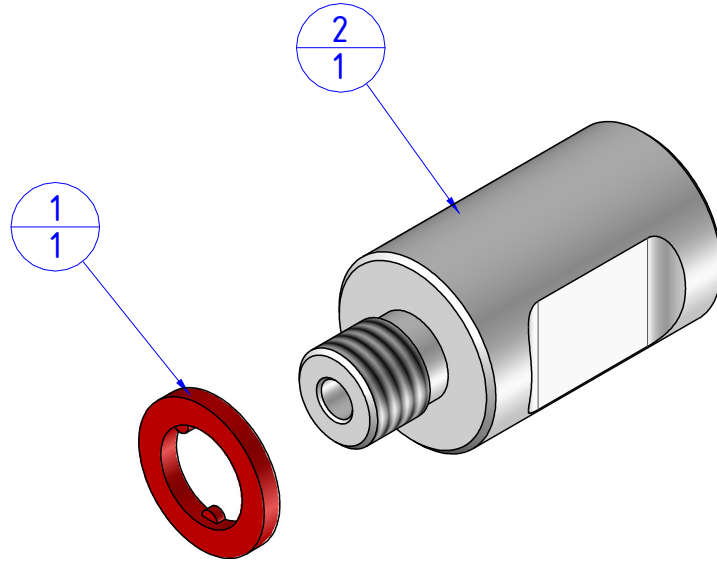

<b>Format</b> A4  <b>UNI 936-76</b>					DESIGNED FROM <b>FPSERVICES</b>	REVIEW <b>A / 2</b>
	GENERAL TOLERANCE UNI - ISO 2768 CLASSE f	DESCRIPTION CA.GSEG.100515			DATE 26/02/2019	WEIGHT 0,003kg
					CODE <b>CA.GSEG.100515</b>	